

ACS



BIBLIOTHÈQUE DE CAISSONS



INFORMATIONS TECHNIQUES

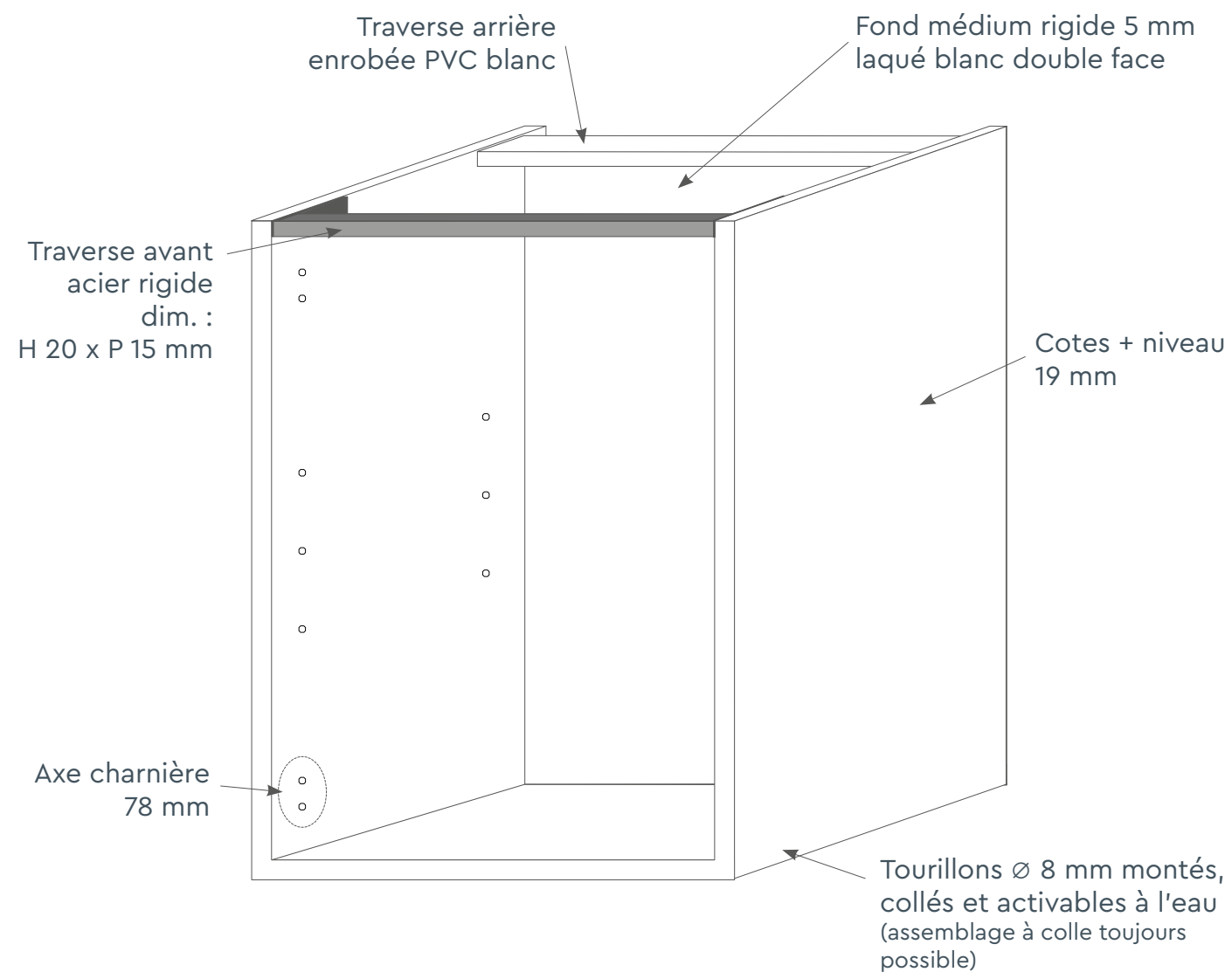

- Côtés disponibles percés charnière
+ étagère pour pouvoir individualiser les types de meubles
- Tourillons + assemblage à visser
- Colis 1 en cartons sans sangle plastique
- Colis 2 sous film plastique retractable
- Trous d'étagère de 3 mm
- Axe charnière 78 mm
- 2 décors stockés (blanc et gris anthracite)
+ 2 décors fabriqués à la contre marque (chêne et gris alu)
- Traverse avant renforcée :
 - supporte toutes charges de plan de travail
 - prépercée fixation plan de travail stratifié

COLORIS CAISSONS

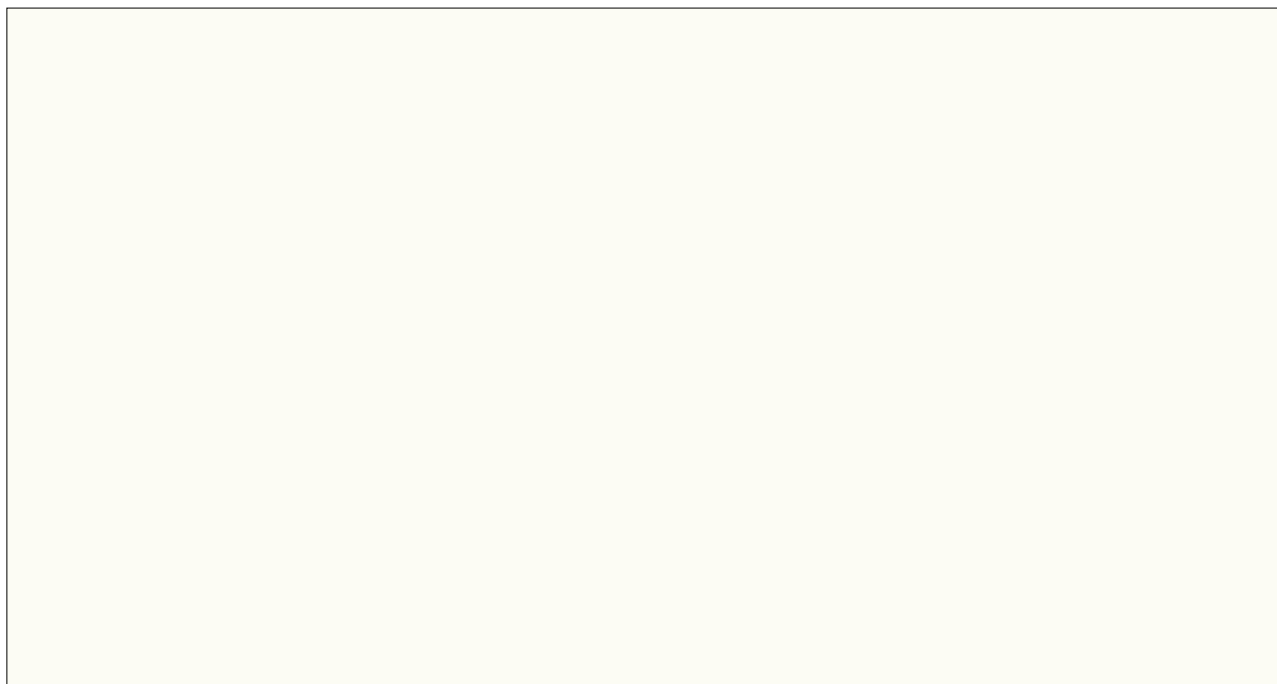

BLANC W980SL ST2
STOCK



C - CHÊNE 98V
SUR COMMANDE



A - ANTHRACITE U963 ST9
STOCK

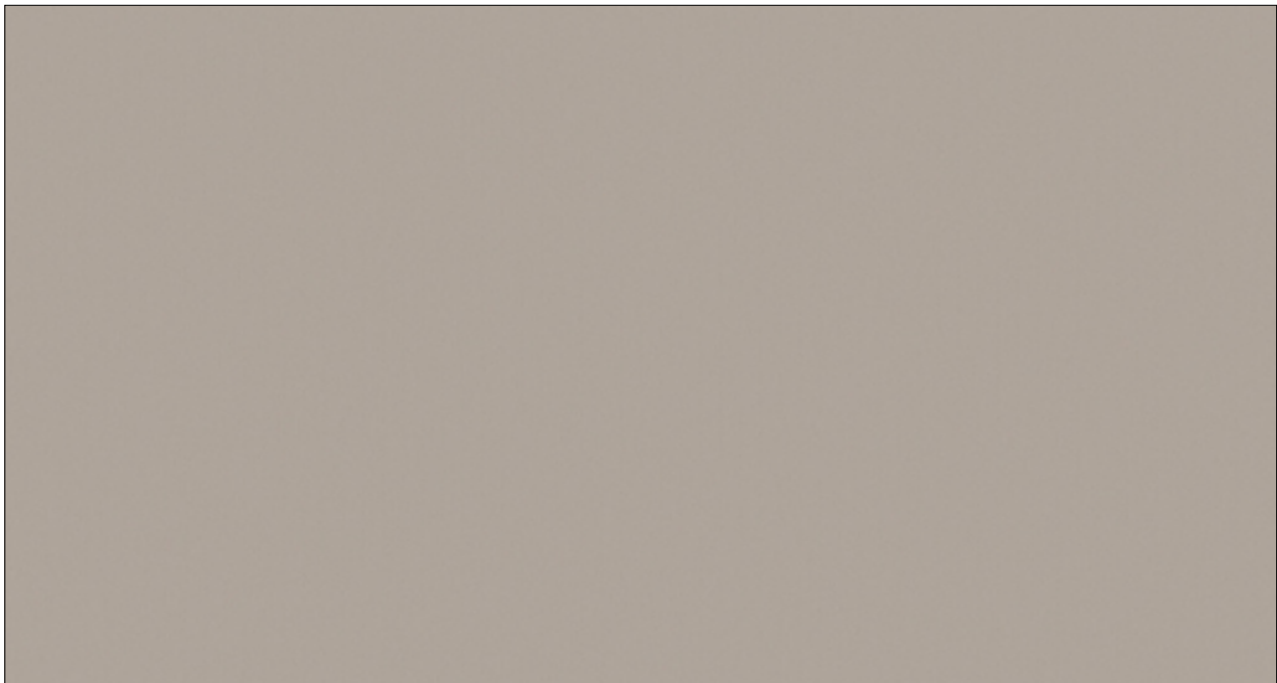

D - GRIS CACHEMIRE
SUR COMMANDE

CAISSONS BAS

CAISSON BAS | HAUTEURS 624/780 ▀ Prof. 580



CB624 CB780

15/30/35/40/45/50/60/70/80/90/100/120

4 Pieds inclus Ht 100-130
À partir de largeur 900 :
6 pieds inclus

CAISSON LAVE VAISSELLE | HAUTEURS 172/328/484 ▀ Prof.

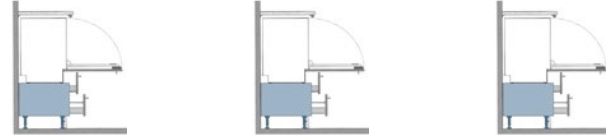

CBLV172 CBLV328 CBLV484

60

CAISSON SOUS ÉVIER | HAUTEURS 624/780 ▀ Prof. 580



CSE624 CSE780

15/30/35/40/45/50/60/70/80/90/100/120

4 Pieds inclus Ht 100-130
À partir de largeur 900 :
6 pieds inclus

CAISSON S/VASQUE | HAUTEUR 700 ▀ Prof. 520



CSV700

60/70/80/90/100/120

CAISSON ANGLE DROIT | HAUTEURS 624/780 ▀ Prof.



CB624 CB780

90/100

4 Pieds inclus Ht 100-130
À partir de largeur 900 :
6 pieds inclus

Pour un Caisson d'Angle :
CB90 ou CB100 + KITBAD

CAISSON SUSPENDU | HAUTEURS 312/468 ▀ Prof. 450



CBS312 CBS468

30/35/40/45/50/60/70/80/90

CAISSON ANGLE | HAUTEUR 780 | 1 OU 2 PORTES ▀ Prof.



CAB1P780 CAB2P780

950

4 Pieds inclus Ht 100-130
À partir de largeur 900 :
6 pieds inclus

CAISSON SUR PLAN | HAUTEURS 1180/1341 ▀ Prof. 580



CSP1185 CSP1341

60

CAISSONS HAUTS

CAISSON SUR HOTTE | HAUTEUR 312

Prof. 330



CSH312
60/80/90

CAISSON RÉDUIT | HAUTEUR 468

Prof. 330



CHR468
60/80/90

CAISSON HAUT | HAUTEURS 624/780

Prof.



CH624 | CH780
30/35/40/45/50/60/70/80/90/100

CAISSON ANGLE | HAUTEURS 624/780 | 1 OU 2 PORTES

Prof.



CAH1P624 | CAH2P624 | CAH1P780 | CAH2P780
650

CAISSON MICRO ONDE | HAUTEURS 624/780

Prof.



CHMP624 | CHMP780
60

NICHES

NICHES BASSES | HAUTEURS 312/468/624/780

Prof. 330



NB312 | NB468 | NB624 | NB780
60/80/100

4 Pieds inclus Ht 100-130
À partir de largeur 900 :
6 pieds inclus

NICHES HAUTES | HAUTEURS 312/468/624/780

Prof. 330



NH312 | NH468 | NH624 | NH780
60/80/100

CAISSONS ARMOIRE

Prof. 580 4 Pieds inclus Ht 100-130

HAUTEUR 1380

HAUTEUR 1680

HAUTEUR 2004

HAUTEUR 2160



CA1380
40/60



CA1680
40/60



CA1380
40/60



CA1680
40/60

Prof. 330

HAUTEUR 1380

HAUTEUR 1680

HAUTEUR 2004

HAUTEUR 2160



CAPR1380
40/60



CAPR1680
40/60



CAPR1380
40/60



CAPR1680
40/60

COMPLÉMENTS ET ACCESSOIRES

SOCLES

DÉSIGNATION	RÉF.	FINITION	DIMENSIONS
SOCLE PVC ALU	SOCPVCALU100	PVC ALU	Ht 100 × 4000 mm
	SOCPVCALU120		Ht 120 × 4000 mm
ANGLE Variable	ANGSOCPVCALU100	PVC ALU	Angle variable 90/135°
	ANGSOCPVCALU120		
SOCLE PVC BLANC	SOCPVCBLC100	PVC BLANC BRILLANT	Ht 100 × 4000 mm
	SOCPVCBLC120		Ht 120 × 4000 mm
ANGLE Variable	ANGSOCPVCBLC100	PVC BLANC BRILLANT	Angle variable 90/135°
	ANGSOCPVCBLC120		
SOCLE PVC NOIR MAT	SOCPVCNOIR100	PVC NOIR MAT	Ht 100 × 4000 mm
	SOCPVCNOIR120		Ht 120 × 4000 mm
ANGLE Variable	ANGSOCPVCNOIR100	PVC NOIR MAT	Angle variable 90/135°
	ANGSOCPVCNOIR120		
SOCLE MASSIF ALU MAT	SOCALU100	PVC ALU MASSIF	Ht 100 × 4000 mm
	SOCALU120		Ht 120 × 4000 mm
ANGLE	ANGSOCALU100	PVC ALU MASSIF	Angle variable 90/135°
	ANGSOCALU120		
CLIPS ALU	CLIPSOCALU	ALU	
CLIPS PVC	CLIPSOCPVC	PVC	

ÉTAGÈRES

▀ Prof. 500 pour caisson bas

EB30 EB35 EB40 EB45 EB50 EB60 EB70 EB80 EB90 EB100 EB120
30/35/40/45/50/60/70/80/90/100/120

▀ Prof. 280 pour caisson haut

EB30 EB35 EB40 EB45 EB50 EB60 EB70 EB80 EB90 EB100 EB120
30/35/40/45/50/60/70/80/90/100/120

▀ Prof. 500 pour caisson armoire

EF60
60



JAMBAGE

JAMB900X580

POTELET

POTELET1780B

FILEURS | POUR CAISSON BAS ET HAUT

F624M F780M

FILEURS | POUR ARMOIRE

F1380M F1680M F2004M F2160M

CONTRE FILEURS | POUR CAISSON HAUT

F624M F780M

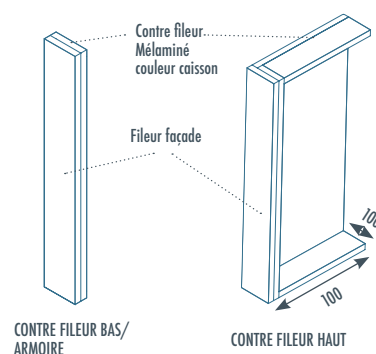

PIEDS ET SUSPENSIONS

DÉSIGNATION	RÉF.
POCHE DE 4 PIEDS HT 100-130	PIED120
POCHE DE 2 SUSPENSIONS POUR MEUBLES HAUTS	119.60001925
POCHE DE 2 SUSPENSIONS POUR MEUBLES SUSPENDUS	SUSPENBAS



ACS

121 av Jean-Baptiste Godin
33240 Saint-André-de-Cubzac

contact@acs-espaces.fr
05.56.32.81.81
www.acs-espaces.fr

